

INSTALLATION INSTRUCTIONS

Y1-1052

METAL CYLINDRICAL HAND SHOWER

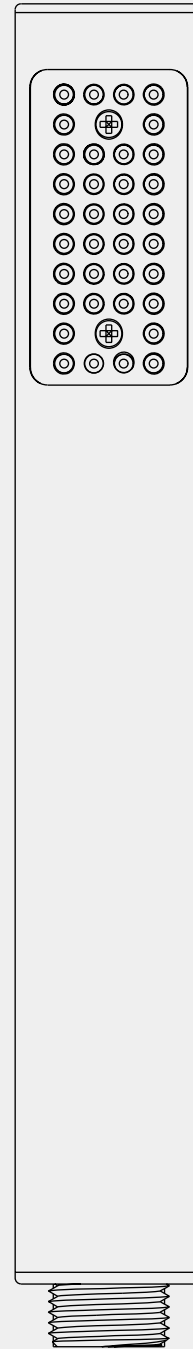

LEFROY BROOKS

Dimensions in Inches (& Millimetres)

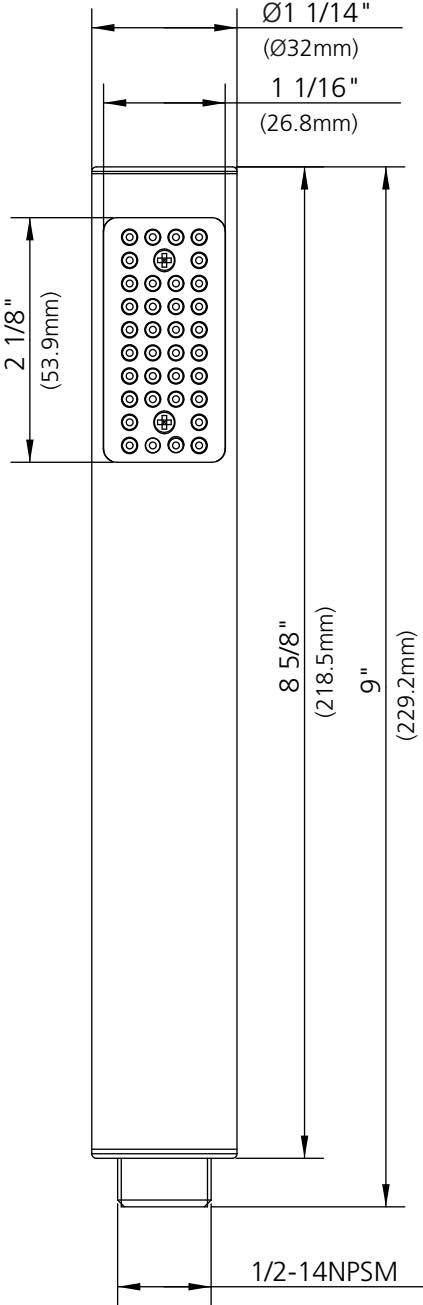

Whilst every effort is made to ensure accuracy, design and dimensions are subject to change without notice as part of the company's product development process.

What you need to know

Tools:

Adjustable Wrench
Groove Joint Pliers
Hacksaw
Phillip Screwdriver
Pipe Tape
Spatula
Spirit Level

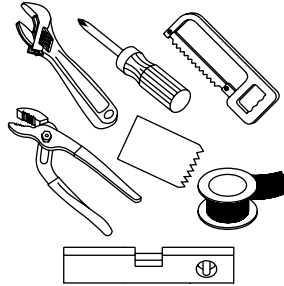

Safety Tips

If you are soldering during faucet installation, remove cartridges, seats, gaskets and washers prior to applying flame, otherwise you will void the warranty.

Cover drain openings to avoid losing small parts.

When cutting or soldering pipe, use safety glasses to protect your eyes.

Things You May Need

Correct installation may vary depending on previous faucet installation. All necessary supplies required for faucet installation are not included, but may be found where plumbing supplies are sold. It is suggested that IAPMO and/or CSA approved plumbing supplies are used during installation.

Standards

IAPMO/cUPC Listed
Meets A112.18.1

Maintenance

Your new bathroom faucet is designed for years of trouble-free performance.

Keep it looking new by cleaning it periodically with a soft cloth. Avoid abrasive cleaners, wire wool and harsh chemicals as these will dull the finish and void your warranty.

Important Points

Prior to beginning installation, turn off the cold and hot water lines and open the old faucet to release built-up pressure.

Overtightening nuts may cause damage.

Wrap all threaded connections with pipe tape available at your local plumbing supply store. Always wrap in a clockwise direction. The fittings should be installed by a state-licensed plumber.

Flow Rate

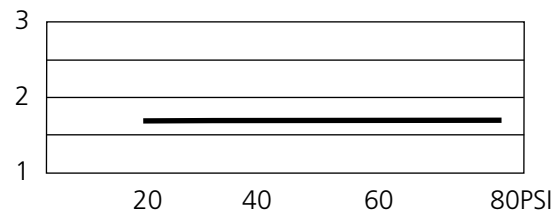

Please note :

Final achievable flow rate is dependent on the outlets fitted, see relevant outlets (spouts, roses, sprays) for fully assembled product flow rate.

Steps 1

Installation Procedure

Lefroy Brooks always recommends that plumbing products be installed by a licensed professional. Shut off main water supply before installation.

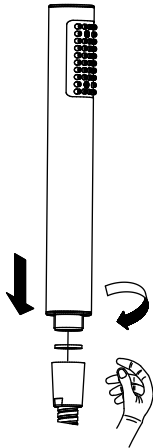

Tighten the handshower to a shower hose (which is not included in this product package) with hand.

This product requires the installation of certified atmospheric vacuum breaker (AVB) installed in-between the shut off valve and hose inlet. The AVB should be installed so it is vent ports is pointing in other than the upward direction. Should you be unfamiliar with an AVB, we recommended consulting a plumbing professional.



valve

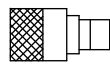

AVB

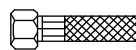

HOSE

Trouble-Shooting

If you've followed the instructions carefully and your faucet still does not work properly, take these corrective steps:

PROBLEM	CAUSE	ACTION

Exploded View

Parts List

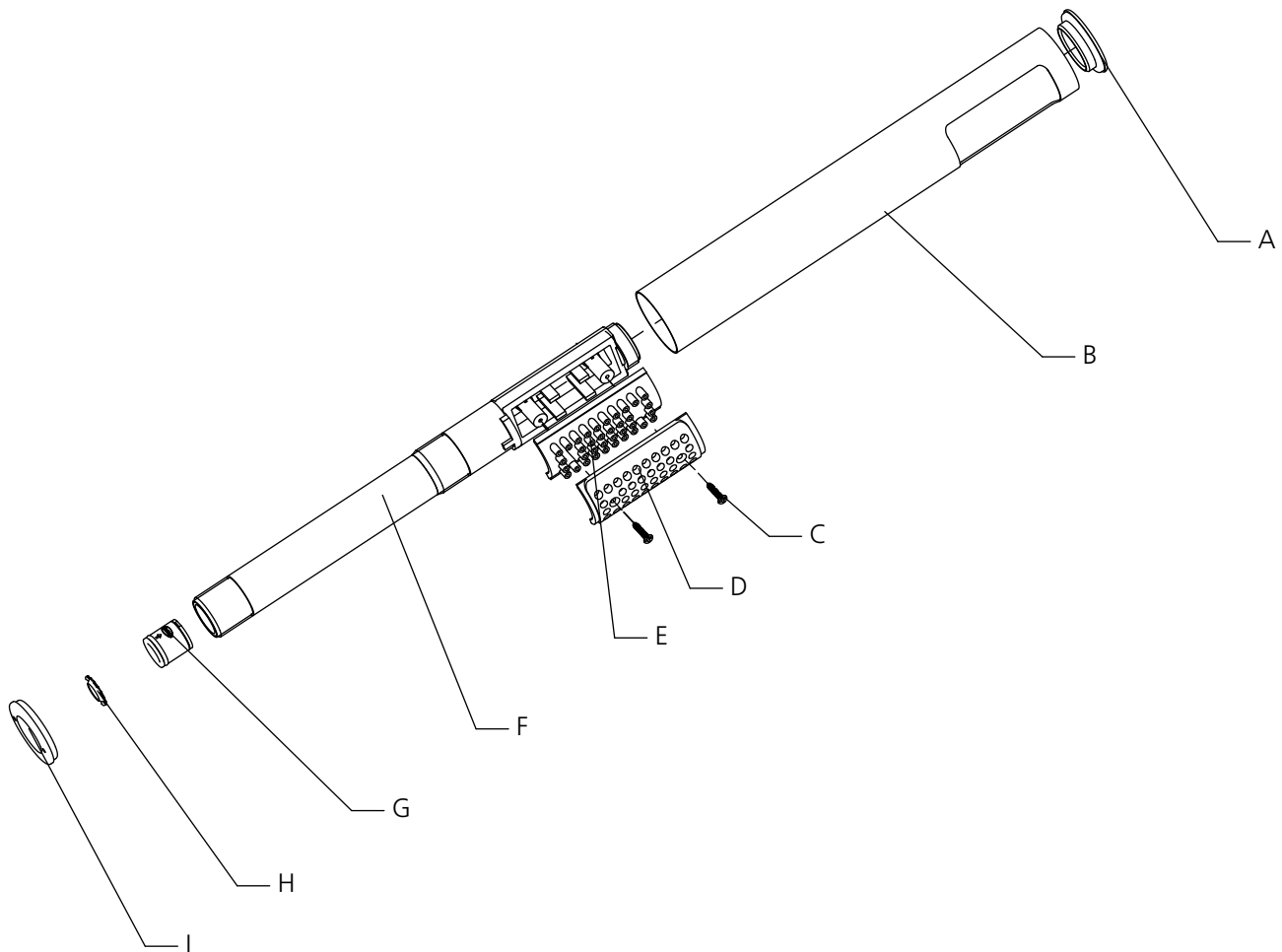

A	Adaptor (057984)	F	Inner tube (033711)
B	Handle sleeve (033711)	G	Non-return valve (519239)
C	Screw (008619)	H	Spring (013990)
D	Front cover (112634)	I	Adaptor (021117)
E	Nozzle (112635)		

For additional assistance or service call

718-302-5292

9am to 5pm EST Monday to Friday

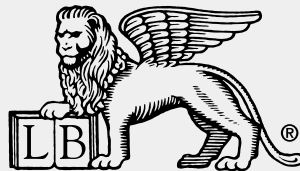

L E F R O Y B R O O K S

www.lefroybrooksusa.com

LEFROY BROOKS INC, 1828 TROUTMAN STREET, RIDGEWOOD, NY, 11385
TELEPHONE: 718-302-5292. FAX: 718-302-4177

The use of trademarks, product design and artwork is subject to licence or agreement with Christo A. Lefroy Brooks. The design registrations, trademark registrations and copyrights are protected by law and the use or reproduction outside the terms of an agreement is prohibited. The right to modify designs and dimensions is reserved. Christo Lefroy Brooks is a member of ACID (Anti Copying in Design).

©CHRISTO A. LEFROY BROOKS 2009